

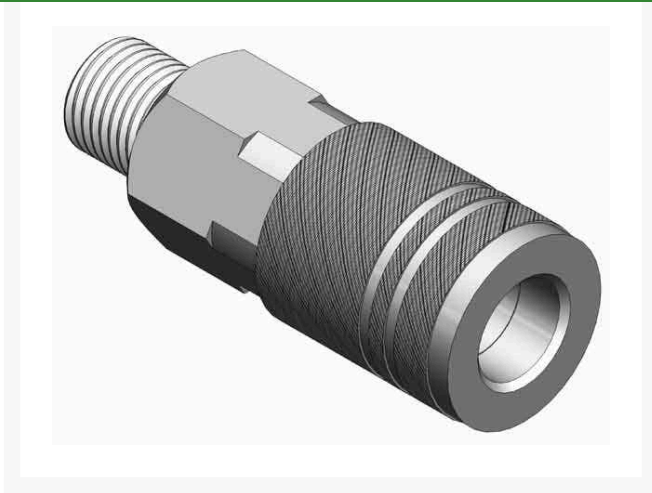

Coupler - 1/4 Nptm R5511



Details

Plated steel couplers with hardened steel balls & stainless steel springs or brass fittings that offer corrosion resistance, ductility at high temperatures, and low magnetic permeability. Maximum working pressure 300 PSI.

Specifications

Manufacturer

R&R Products

GA Power Equipment Spares

11 Sodium St Narangba, 4504

1300 363 004

<https://rgs.rrproducts.com/>